

VOTRONIC

Installation and Operating Manual

| | | |
|--|--------------------------|-----------------|
| Solar Controller MPP 165 Duo Dig. | (12 V / 12 A / 165 Wp) | No. 1710 |
| Solar Controller MPP 250 Duo Dig. | (12 V / 18 A / 255 Wp) | No. 1715 |
| Solar Controller MPP 350 Duo Dig. | (12 V / 25.5 A / 350 Wp) | No. 1720 |
| Solar Controller MPP 430 Duo Dig. | (12 V / 31.5 A / 430 Wp) | No. 1725 |



Please read this assembly and operating instructions completely, in particular, page 2 "Safety Regulations and Appropriate Application", before you begin the connection and start-up.

MPP Solar Controller for high-quality campers, caravans and boats.

VOTRONIC Solar Controllers of series "**MPP**" (**Maximum-Power-Point**) with **characteristic line of charging "IU1oU2"** are the link between solar panel(s) and battery (batteries).

Controllers according to the MPP technology are continuously and automatically calculating the maximum power yield (MPP) of the solar modules several times per minute. The voltage surplus of the solar module will be transformed to a higher charging current for the battery (realised by high-frequency switching controller technology with high efficiency). This surplus of charging current ensures short charging times and the best possible power yield of the solar system.

Working fully automatically and maintenance-free, the solar controllers MPP offer the following functions:

- **Increased MPP charging current** compared with conventional controllers, due to ultramodern controller technology (microprocessor) by 10 % to 30 % (efficiency > 95 %). This enhanced capacity shows particularly in cooler times of the year, such as in case of foggy weather conditions or gloomy diffuse light (winter break).
- **Switchable characteristic lines of charging** or optimum charging of **lead-gel-/dryfit**, **AGM/fleece** or **acid/lead-acid** batteries, as well as **LiFePO4** batteries (see table 1).
- The **charging voltage being free from peaks** is **controlled** in such a way, that any **overcharging** of the batteries is **excluded**.
- **Two Battery Charging Ports:** Automatic charging of the main supply board battery (BOARD I), as well as **support charging** and trickle charging (max. 1 A) of the vehicle's starter battery (Start II) with overcharge protection.
- **Unattended Charging:** Standard protection against overload, overheating, reverse battery and back discharge of the battery (in case of insufficient solar power, such as at twilight, at night etc.).
- **Parallel and Floating Operation:** Observation of the characteristic lines of charging, even with simultaneous operation of consumers.
- **Overcharge protection:** Reduction of the charging current of the battery in case of excessive solar power and full battery. Immediate recharging in case of power consumption to ensure always the best possible charging state of the battery.
- **Characteristic Line of Charging "IU1oU2":** A defined charging boost (U1) avoids harmful acid accumulation (lead) and provides equalization charge to the individual battery cells (lead and lithium). After that, automatic trickle charging (U2).
- **Charging Cable Compensation:** Automatic compensation of voltage losses on the charging cables.
- **On-board Mains Suppression Filter:** Unproblematic parallel operation with wind-driven and motor-driven generators, mains supply chargers, dynamos etc.
- **Measurement Output for EBL**, electroblock possibly existing in the living area of the vehicle: Allows convenient application of the (solar) current display being installed in the electroblock for supervision of the solar system.
- **Terminal "AES"** (only MPP 250, MPP 350 and MPP 430): Automatic commutation of refrigerators with "AES" (Automatic Energy Selector, Electrolux/Dometic) from gas operation to 12 V operation in case of excess solar power.
- **Connection for Battery Temperature Sensor (Order No. 2001):**
Lead batteries: In case of **low outside temperatures**, **full charging** of the weak battery **is improved** by automatic adaptation of the charging voltage to the **battery temperature**, and in case of summery temperatures unnecessary **battery gassing** and battery load will be avoided.
LiFePO4 Batteries: Battery protection in case of high temperatures and particularly in case of low temperatures.
Highly recommended, if the battery temperature might drop below 0 °C during operation.
- **Ready for connection** of the **Votronic Solar Displays** for optimum control of the system:
LCD Solar Computer S: The LCD display indicates the following values: Battery voltage, charging current, charging capacity, stored capacity and energy (V, A, W, Ah, Wh), Order No.: 1250.



Battery Lifetime and Efficiency:

- Keep the batteries cool, **LiFePO4 preferably above 0 °C**. Choose an appropriate location for installation.
- **Store only fully charged batteries and recharge them periodically!**
- **Open lead-acid batteries and batteries being "maintenance-free according to EN / DIN": Check the acid level periodically!**
- **Recharge totally discharged lead batteries immediately!**
- **LiFePO4: Only use complete batteries with BMS and safety circuit.**
Total discharge is absolutely to be avoided!



Safety Regulations and Appropriate Application:

The solar controller has been designed according to the valid safety regulations.

Appropriate application is restricted to:

1. **Charging of lead-gel, lead-AGM, lead-acid or LiFePO4-complete-batteries (with integrated BMS, equalization charging of the cells/balancing and approval!) of the indicated nominal voltage and simultaneous supply of the consumers being connected to these batteries in fixed installed systems.**
 2. **With solar panels up to the maximum power rating (Wp) of the used solar controller.**
 3. **With solar panels below the max. admissible voltage (Voc).**
 4. **The indicated cable cross-sections at the charging ports and at the panel input.**
 5. **With fuses of the indicated capacity near the battery to protect the cabling between battery and charging ports.**
 6. **Technically faultless condition.**
 7. **Installation in a well-ventilated room, protected from rain, humidity, dust, aggressive battery gases, as well as in an environment being free from condensation water.**
 8. **The device must not be operated on the input terminals "+/-solar panels" with wind, water, fuel or motor generators, power supplies, batteries or other power sources!**
- **Never use the unit in locations where the risk of gas or dust explosion exists!**
 - Cables are always to be laid in such a way that damage is excluded. Observe to fasten them tightly.
 - **Always lead the connection cables from below to the solar controller to ensure that penetrating humidity cannot reach the controller in case of failure, which might result in damage of the controller.**
 - Never lay 12 V (24 V) cables and 230 V mains supply cables into the same cable conduit (empty conduit).
 - Check live cables or leads periodically for insulation faults, points of break or loosened connections. Occurring defects must be remedied immediately.
 - The unit is to be disconnected from any connection prior to execution of electrically welding or work on the electric system.
 - If the non-commercial end-user is not able to recognize the characteristic values being valid for a unit or the regulations to be observed, a specialist is always to be consulted.
 - The user/buyer is obliged to observe any construction and safety regulations.
 - **Except for the fuse, the unit is not equipped with parts, which can be replaced by the user.**
Always use replacement car fuses of the indicated capacity!
 - Keep children away from the solar controller and the batteries.
 - Observe the safety regulations of the battery manufacturer.
 - Deaerate the battery room. Protect the unit from aggressive battery gases.
 - Ensure **sufficient ventilation** of unit and panel!
 - Strictly observe the instructions of the manufacturer for installation of the solar panel.
 - Non-observance may result in injury or material damage.
 - The warranty period is 36 months from the purchase date (against presentation of the sales slip or invoice).
 - The guarantee will be void in case of any inappropriate utilisation of the unit, if it is used beyond the technical specification, in case of improper operation, **intrusion of water** or external intervention. We do not assume any liability for any damage resulting hereof. The liability exclusion is extended to any service being executed by third, which has not been ordered by us in writing. Service is to be effected exclusively by VOTRONIC, Lauterbach.

Connection Plan:

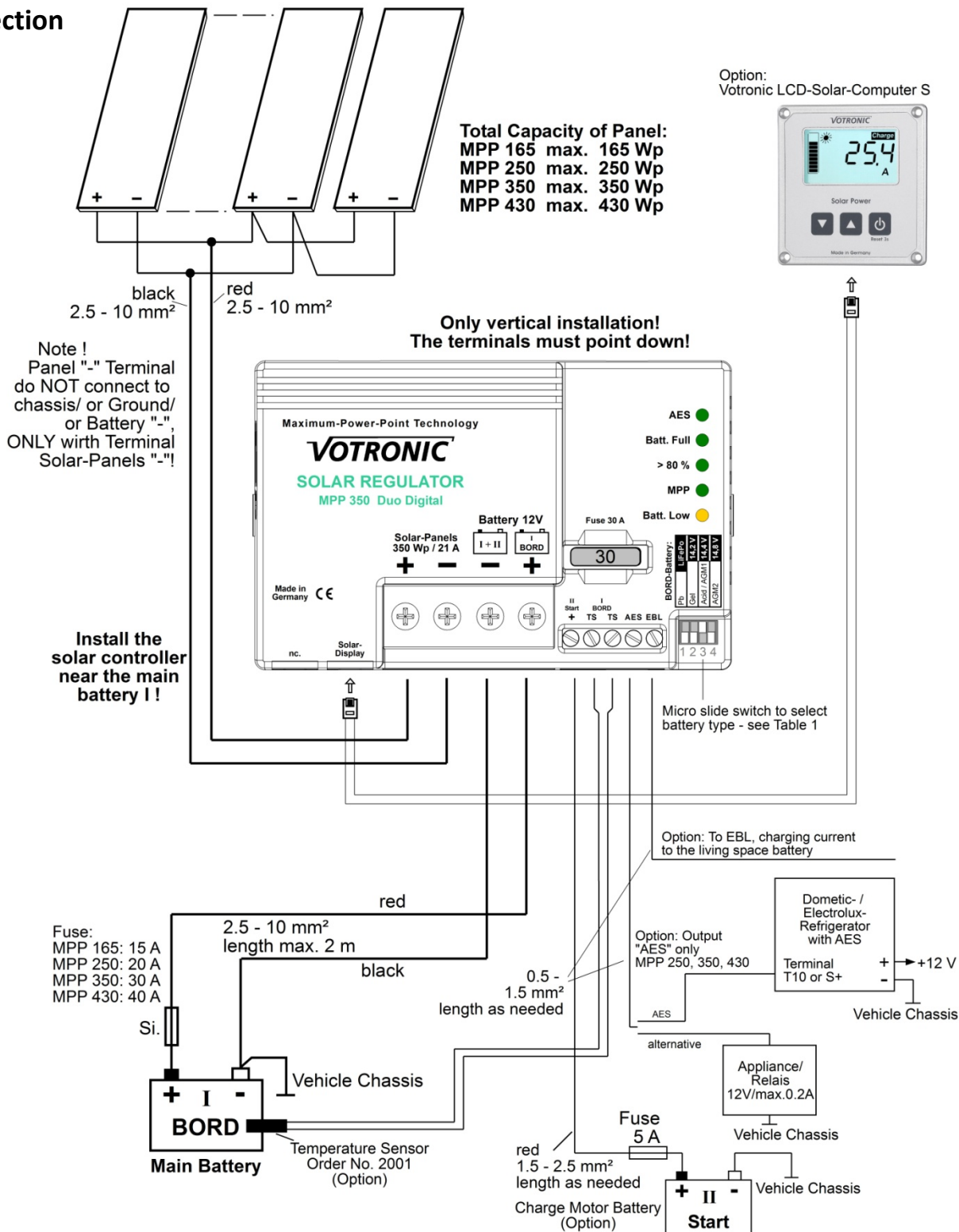

Note:

The connection plan shows the **maximum terminal assignment** for operation of all existing functions of the solar controller. The **minimum terminal assignment** consists of the solar panel inputs ("+" and "-") and the connections to the main battery.

Always connect the fuses as close as possible to the batteries (cable protection!).

| Required Cable Cross-Sections, Notes | MPP 165 | MPP 250 | MPP 350 | MPP 430 |
|---|-----------------------|---------------------|----------------------|----------------------|
| +/- Panel cables, length as required: | 2.5-4 mm ² | 4-6 mm ² | 6-10 mm ² | 6-10 mm ² |
| +/- Battery I cables, length max. 2 m: | 2.5-4 mm ² | 4-6 mm ² | 6-10 mm ² | 6-10 mm ² |
| Fuse close to battery I (cable protection): | 15 A | 20 A | 30 A | 40 A |

Cut-off Relay:



The cut-off relay, which exists in most of the vehicles, can, of course, still be used. (For charging by the dynamo, the cut-off relay connects the board battery to the starter battery during running motor of the vehicle. The cut-off relay is not included in the connection plan).

Mounting:

Screw-down the solar controller on an even and **hard mounting surface** at locations **being protected from humidity** and **near the main/board battery (BOARD I)** to ensure that the length of the battery connection cable is **as short as possible**.

Vertical installation of the controller is highly recommendable (the **terminals** for solar panel and batteries **point down**).

This mode of installation improves cooling of the unit and **avoids that water runs along the connection cables** of the solar panel **into the solar controller**, even in case of damaged seals.

If used, the cable to the starter battery (START II) can be longer.

Despite the solar controller's high efficiency, heat is produced. Ensure sufficient **ventilation in the environment of the unit**, so that the heat can be carried-off.

The unit might heat-up. Consequently, the **vent holes** of the casing should never be covered to ensure full charging capacity (**minimum distance** all around: **10 cm**).

Connection (See Connection Plan):

- **Observe the cable cross-sections and cable lengths indicated in the connection plan and the tables!**
- **The correct polarities (+ and -) of solar panel and batteries are absolutely to be observed!**
- **Cable protection: Insert the fuses near the batteries into the + cables (protection against cable fire) !**

1.) Main / Board Battery "BOARD I" (must be connected):

Connect the **battery connections** of the controller - (minus) and + (plus) to the 12 V main battery, observing the correct polarity and the cross-section of the cables (**refer to connection plan**).

Never operate the controller without the battery „BOARD I“. If the battery is not connected, the unit will not deliver a defined output voltage.

In case of wrong polarity of battery I, the internal safety fuse will be released. The replacement fuse should have the same capacity, and it should be of the same type (car fuse)!

Parallel charging of two or several batteries of the same voltage (12 V) is admissible. The batteries are to be "paralleled", i. e. the "+" connections of the batteries have to be coupled and should be connected to the "+" connection of the solar controller. The minus (-) connections have to be coupled in the same way.

According to the battery manufacturers, **permanent** parallel operation in cross connection is admissible in case of two or several batteries of the same voltage, same type, same capacity, as well as of the same age (history) .

2.) "Solar Panels" (must be connected):

Shade the panels to minimize sparking during connection and to avoid damages due to eventual reverse battery (hall).

Observe the cable cross-sections (**refer to connection plan**)!

If **several small solar panels** are used, they are connected in parallel. Partial shading of the panels or of parts of the panels (leaves, branches, dirt etc.) results in average higher solar power (**see connection plan**).



The (-) **minus connection of the solar panel** must **exclusively** be connected to the (-) **minus terminal of the solar controller!**

Any further connection (possibly from the connection of a former solar controller, damaged insulation at the roof cable duct etc.) to the battery minus (-) or to the vehicle (-) chassis might falsify the internal current metering of the unit and is not admissible.

3.) Starter Battery "Start II" (Option, can be connected):

Connect the **second charging port** to the vehicle's starter battery using the red connection cable (**wire cross-section 1.5-2.5 mm²**). This cable may be longer. In case of **non-utilization**, this terminal is **left free**.

If used, the output for the vehicle's starter battery will be working with reduced voltage and charging current rates. Thus, the valuable solar power will be supplied to board/solar battery I being more suitable.

However, the vehicle's starter battery will be kept in a condition, that starting will always be possible, even in case of longer stop periods (such as in winter).



Usually, the **minus poles** of the starter battery ("Start II") and of the supply battery ("BOARD I") had already been connected by the customer.

If not, this connection must be made for charging of the starter battery.

4.) Plug-type Connection "Solar Display" (Option, can be connected):

6-pole tip jack for connection of the plug-and-go **Votronic Solar Displays** for optimum control of the solar system:

LCD Solar Computer S: The LCD display indicates the following values: Battery voltage, charging current, charging capacity, stored capacity and energy (V, A, W, Ah, Wh). Order No.: 1250.

5.) "EBL" Connection for Electroblock with Display Panel DT... / LT... (Option, can be connected):

A cable set for connection of the solar controller to the EBL is required. **Order No.: 2007** (It is not included in the standard delivery scope of the controller).

The solar controller supplies a signal at the terminal "EBL" for display of the solar charging current, which is suitable for electroblock EBL... with DT.../LT... display panel.

The signal cable being required for that, as well as a connection cable for connection of the solar controller to the EBL are included in the set of EBL connection cables. Cable Length: 1 m, each:

6.) "AES" (Automatic Energy Selector) only MPP 250, MPP 350, MPP 430 (Option, can be connected):

The delivery scope of Dometic / Electrolux and of other companies includes "AES" refrigerators with all-automatic energy selection (230 V AC, 12 V DC or gas).

Particularly in summer, a lot of excess energy might be produced due to strong solar radiation, full batteries and low energy consumption, which is left unused. The solar controller recognizes this condition and uses the "AES" output to give a signal to the refrigerator, which will switch from gas operation to 12 V operation to benefit from the excess energy (gas saving).

Connection:

Lead a single-pole cable (0.5-1.5 mm²) from the solar controller's terminal "AES" to the refrigerator's terminal "T10" or "S+".

Function:

The solar controller recognizes the excess capacity (LED "AES" is lighting). Then, the refrigerator switches from gas operation to 12 V operation. This mode will be kept for at least half an hour to avoid that the refrigerator will be "swinging" between 12 V operation and gas operation.

Should the solar power be still sufficient, the 12 V operation of the refrigerator will be kept.

Should the solar power be insufficient, "AES" will be switched-off by the solar controller, the refrigerator will be switched to gas operation, it will keep this mode for at least half an hour, and the solar power will be used for recharge of the (possibly slightly discharged) battery. This mode of operation can only be taken into account in case of sufficient efficiency of the solar panel and under favourable conditions, such as 110 Wp, better from 150 Wp or more.

Optionally:

Optionally, small 12 V consumers can be operated at the AES output, such as 12 V fans, car relays or refrigerators with control input D+ (Thetford etc.).

For these applications, it must be observed, that the output must be active for at least half an hour.



The output current of the terminal "AES" is 12 V, max. 0.2 A. In case of larger consumers, the output is limited and can again be loaded after a cooling down phase.

Supply of larger consumers requires interconnection of a load relay.

7.) Input Battery Temperature Sensor (Option, can be connected):

Connection for the external **Votronic Temperature Sensor**, **order No. 2001** (is not included in the standard delivery scope).

- Measurement of the **battery temperature** of the board supply battery "I" for battery protection and battery control.
- Connect the sensor to **the terminals "TS - TS"** (any polarity).
- Ensure that the installation place of the **sensor is not influenced by any source of heat** (engine block, exhaust, heater etc.)!

Lead-Acid, Gel, AGM Batteries:

Installation: The thermal contact of sensor and battery inside temperature should be well. Thus, it should be screwed down to the negative pole or positive pole of the battery. It is also possible to fasten it at the sidewall centre of the battery casing.

Effect: The temperature-dependent charging voltage of **battery I will be adapted automatically to the battery temperature (automatic temperature equalization)**. The temperature sensor measures the battery temperature. In case of low temperatures (winter operation), the charging voltage will be increased, in order to improve and accelerate full charging of the weak battery. Sensitive consumers are protected by a limitation of the voltage in case of very low outside temperatures.

In case of summery temperatures, the charging voltage is reduced to minimize the load (gassing) of the battery and to extend the lifetime of gas-tight batteries.

Battery Protection: In case of excessive battery temperatures (from +50 °C), the charging voltage will be reduced strongly to **safety charging voltage**, approx. 12.80 V, for battery protection and the maximum charging current rate will be halved and safety mode, LED "**MPP" is flashing** ("Charge" at MPP 165). Any charging data being recorded hitherto will be kept in memory.

Battery charging is then interrupted, but the supply of consumers being possibly connected will be continued by the solar controller, and the battery is allowed to cool down. After that, automatic charging will be resumed. Also refer to "**Charging Voltage Rates and Temperature Equalization, as well as Protection of BOARD Battery I**" on page 10.

LiFePO4 Batteries:

Installation: The **thermal contact** of sensor and **inside temperature of the battery should be well**. Thus, it should be screwed down to the **negative pole** of the battery, because in case of LiFePO4 batteries, in most of the cases, this is the cooler side (the positive pole is often falsified with the exhaust heat of internal fuses, electronic systems for cell equalization etc.)

Effect: In case of abnormal battery temperatures, such as <-20 °C, >50 °C, the charging voltage will be reduced strongly to **safety charging voltage**, approx. 12.80 V, for battery protection, and the maximum charging current rate will be halved. Safety mode, LED "**MPP" is flashing** ("Charge" at MPP 165). Any charging data being recorded hitherto will be kept in memory.

Battery charging is then interrupted, but the supply of consumers being possibly connected will be continued by the solar controller until the battery temperature is in the admissible range. After that, automatic charging will be resumed.

Below 0 °C, the charging current will be reduced very strongly for battery protection, and longer charging times can be expected.



The solar controller recognizes automatically a missing sensor, cable break or short-circuit of the sensor lines, as well as unreasonable measuring values. In that case, it will switch automatically to the usual charging voltage rates of 20 °C / 25 °C being recommended by the battery manufacturers.

Pilot Lamps:

"AES": Excess power display at MPP 250, MPP 350 and MPP 430, **green**

- If it is lighting: Sufficient excess solar power is available, the output "AES" for automatic energy selection of the refrigerator or of a relay control is activated.
- Off: Output "AES" is switched-off.

"Batt. Full": Battery fully charged, **green**

- If it is lighting: Battery (batteries) has (have) been charged to 100 %, trickle charging U2, finished.
- If it is lighting dimly: Main charging process is still effected in the charging phase U1.
- Off: Main charging process is still effected in the charging phase I.

">80 %": green

- If it is lighting: The solar controller is in the charging phase U1, the battery will be charged fully.

"Charge": only MPP 165, **green:**

- If it is lighting: The brightness from slight dimly lighting up to full brightness indicates the charging current intensity.
- Off: Solar power is insufficient.
- If it extinguishes shortly every 2 sec.: Only LiFePO4, protection: Battery temperature below 0 °C, strong limitation of the charging current.
- If it is flashing 3 times per sec.: Battery protection:
 1. Switchover to safety charging voltage, battery overtemperature >+50 °C, automatic return and continued charging in case of temperature drop of the battery by 2 °C.
 2. Disconnection, caused by overvoltage at the battery.

"MPP": MPP 165 control, **green**

- If it is lighting: Proper functioning of the solar controller.
- Short flashing every 2 sec.: Display of readiness for service in case of missing solar power (at night).

"MPP": MPP 250, MPP 350 and MPP 430, control, **green**

- If it is lighting: Proper functioning of the solar controller. The brightness from slight dimly lighting up to full brightness indicates the charging current intensity (capacity).
- Short flashing every 2 sec.: Display of readiness for service in case of missing solar power (at night).
- If it is flashing 3 times per sec.: Battery protection:
 1. Switchover to safety charging voltage, battery overtemperature >+50 °C, automatic return and continued charging in case of temperature drop of the battery by 2 °C.
 2. Disconnection, caused by overvoltage at the battery.

- If it extinguishes shortly every 2 sec.: Only LiFePO₄, protection: battery temperature below 0 °C, strong limitation of the charging current.

"Batt. Low": yellow

- If it is lighting: Low voltage at board battery I. The battery should be recharged as soon as possible!

All light-emitting diodes "AES", "Batt. Full", ">80 %", "Charge", "MPP", "Batt. Low" are flashing simultaneously: The positions of the selector switches "BOARD Battery" are **incorrect**. For reasons of safety, the solar controller is switched-off. Adjust the desired battery type according to table 1.

Operating Instructions:

- **Lifetime of the battery:**
 - **Recharge totally discharged batteries immediately:**
Incipient **Sulphation** of the lead battery plates due to total discharge is to be prevented by **soon charging**, particularly in case of high ambient temperatures. If the grade of sulphation is not too intensive, the battery can recover part of the battery capacity after **several charging/discharging cycles**.
Total discharge of LiFePO₄ batteries is absolutely to be avoided!
 - **Partially discharged batteries:**
In contrast to other battery types, batteries on lead and LiFePO₄ basis **do not have any** harmful memory effect. Consequently: In case of doubt, partially discharged batteries have to be **charged fully** as soon as possible. **Always store only fully charged lead batteries.** Recharge them periodically, particularly in case of used (older) batteries and higher temperatures.
 - Keep the batteries cool and dry, LiFePO₄ batteries preferably above 0 °C. Choose an appropriate location for installation.
 - In case of **insufficient solar power** and/or high current consumption, the lead battery should be subject to occasional full charging by means of a mains supply charger.
 - **Overvoltage Protection:**
The 12 V solar controllers protect themselves against connection of excessive battery voltage rates or will be switched-off in case of defective additional charging systems (chargers, generators or similar systems), switching threshold 15.0-16.0 V, depending on the battery type.
 - **Overvoltage Limitation:**
Sensitive consumers are protected by means of a limitation of the charging voltage to max. 15.0 V during all modes of charging.
 - **Overload/Overheating Protection Solar Controller:**
The solar controller is equipped with a double electronic protection against overload and with an automatic protection against adverse installation conditions (e. g. insufficient ventilation, excessive ambient temperatures) by gradual reduction of the charging capacity.
 - **Voltage Measurement:** The voltage rates at the solar controller might be falsified by losses at the charging cables. Never use the controller without battery.
 - **Operation with switched off LiFePO₄-BORD I battery:**
 - In case the battery is disconnected from the solar charging controller by the (prescribed) BMS, the latter will, as long as the solar power is adequate, provide the set voltage at its output terminals according to the characteristic line of charging. Consumer units continue to be supplied by the solar charging controller as long as they have not been separately disconnected from the BMS and the solar power is adequate.
 - Whether a battery disconnected by the BMS will switch back on by itself and can therefore continue to be automatically charged by the solar charging controller depends on the type of battery and its BMS.
 - The charge of battery II (starter lead battery) continues to be retained if there is sufficient solar power.

TIP

In case of unattended operation, the battery might be totally discharged due to too many consumers and lack of solar power. We recommend an (undervoltage) protection for the battery by means of the following appliances:





- | | | |
|---------------------------------------|-----------------------------|--------------------------|
| Votronic Battery Protector 40 | (Power rating 12 V / 40 A) | Order No. 3075 or |
| Votronic Battery Protector 100 | (Power rating 12 V / 100 A) | Order No. 3078 |





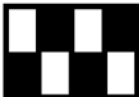

Table 1: For Main Battery I: How to set the correct charging program for the battery type (design, lead or lithium-iron phosphate technology)



Prior to start-up, imperatively set the correct characteristic line of charging being suitable for the battery to avoid battery damages!

Set the **slide switch ("BOARD Battery")** to the desired position for **battery I (board battery)** using a small screwdriver. Either **select Lead Battery** or **Lithium LiFePO4 Battery** using switch "1". After that, select the desired characteristic line of charging using the switches "2", "3" and "4", as indicated in the tables:

| | | | | | | | | | | | | | |
|--|--|------------------------|-------------|--------|-----------|-----------------------------------|---------|--------|------------|---|---------|----------|--|
| <p>Switch 1 "below": Lead-Batteries</p>  <p>1 2 3 4</p> | <p>a) – c): Charging programs for lead-batteries:</p> <p>If not being specified divergently by the battery manufacturer, the suitable charging program for the battery type (design, technology) can be determined by means of the following description and the technical data (voltage rates U1 and U2, nominal temperature and dwell times U1).</p> <p>Note: The possible parallel/floating operation with consumers being connected to the battery is also automatically considered by all charging programs.</p> | | | | | | | | | | | | |
|  <p>1 2 3 4</p> | <p>a) "Gel" : Charging program for gel/dryfit batteries:</p> <p>Adapted to closed, gas-tight Gel batteries with determined electrolytes, which are generally requiring a higher charging voltage level and longer dwell times U1 to achieve short charging times with particularly high capacity storage and to avoid total discharge, e. g. EXIDE, Sonnenschein dryfit- Start, Dryfit-Sport-Line, DETA Gel Battery Funline, Bosch AS Gel Batteries Va/Z, AS Gel Drive Batteries, AS Gel lighting batteries.</p> <p>If not being specified divergently by the battery manufacturer, also recommended for batteries in round cell technology.</p> <p>EXIDE, DETA, VARTA Characteristic Line Gel IU1oU2:</p> <table border="0"> <tr> <td>U1 Main/Full Charging:</td> <td>14.30 V</td> <td>+20 °C</td> <td>1.5-6 h</td> </tr> <tr> <td>U2 Full/Trickle/Storage Charging:</td> <td>13.80 V</td> <td>+20 °C</td> <td>Continuous</td> </tr> <tr> <td>Safety mode at excess temperature of the battery:</td> <td>12.80 V</td> <td>> +50 °C</td> <td></td> </tr> </table> | U1 Main/Full Charging: | 14.30 V | +20 °C | 1.5-6 h | U2 Full/Trickle/Storage Charging: | 13.80 V | +20 °C | Continuous | Safety mode at excess temperature of the battery: | 12.80 V | > +50 °C | |
| U1 Main/Full Charging: | 14.30 V | +20 °C | 1.5-6 h | | | | | | | | | | |
| U2 Full/Trickle/Storage Charging: | 13.80 V | +20 °C | Continuous | | | | | | | | | | |
| Safety mode at excess temperature of the battery: | 12.80 V | > +50 °C | | | | | | | | | | | |
|  <p>1 2 3 4</p> | <p>b) "Lead Acid/AGM1": Charging program for acid/lead-acid batteries as well as AGM 14.4 V:</p> <p>For charging and trickle charge of supply (board) batteries. Ensures short charging times, high charging factor and acid mixing for open standard batteries and closed, low-maintenance, maintenance-free "non-solid electrolyte", "lead-acid", drive, lighting, solar and heavy duty batteries. Also suitable for recently developed batteries (low-antimonous, batteries with silver-alloy, calcium/calcium or similar) and batteries with low and very low water consumption, as well as AGM batteries with the indication 14.4 V.</p> <p>Characteristic line of charging IU1oU2 Acid/AGM:</p> <table border="0"> <tr> <td>U1 Main/Full Charging:</td> <td>14.40 V</td> <td>+20 °C</td> <td>0.5-4 h</td> </tr> <tr> <td>U2 Full/Trickle/Storage Charging:</td> <td>13.45 V</td> <td>+20 °C</td> <td>Continuous</td> </tr> <tr> <td>Safety mode at excess temperature of the battery:</td> <td>12.80 V</td> <td>> +50 °C</td> <td></td> </tr> </table> | U1 Main/Full Charging: | 14.40 V | +20 °C | 0.5-4 h | U2 Full/Trickle/Storage Charging: | 13.45 V | +20 °C | Continuous | Safety mode at excess temperature of the battery: | 12.80 V | > +50 °C | |
| U1 Main/Full Charging: | 14.40 V | +20 °C | 0.5-4 h | | | | | | | | | | |
| U2 Full/Trickle/Storage Charging: | 13.45 V | +20 °C | Continuous | | | | | | | | | | |
| Safety mode at excess temperature of the battery: | 12.80 V | > +50 °C | | | | | | | | | | | |
|  <p>1 2 3 4</p> | <p>c) "AGM2": Charging program for AGM / Fleece batteries 14.7 V:</p> <p>Adapted to closed, gas-tight AGM (absorbed glass mat) batteries and batteries in lead-fleece technology, Lead Crystal, VRLA, requiring a particularly high level U1 for full charging.</p> <p>ATTENTION: It is highly recommended to check the specification sheet of the battery concerning the high charging voltage U1 14.7 V.</p> <p>Unsuitable batteries might age prematurely due to loss of electrolyte!</p> <p>Some manufacturers of AGM/fleece batteries are also prescribing a 14.4 V charging program for charging! In these cases, please set "Lead Acid/AGM1" (14.4 V / 13.45 V).</p> <p>Characteristic Line AGM/Fleece IU1oU2:</p> <table border="0"> <tr> <td>U1 Main/Full Charging:</td> <td>14.70 V (!)</td> <td>+20 °C</td> <td>0.5-3.5 h</td> </tr> <tr> <td>U2 Full/Trickle/Storage Charging:</td> <td>13.50 V</td> <td>+20 °C</td> <td>Continuous</td> </tr> <tr> <td>Safety mode at excess temperature of the battery:</td> <td>12.80 V</td> <td>> +50 °C</td> <td></td> </tr> </table> | U1 Main/Full Charging: | 14.70 V (!) | +20 °C | 0.5-3.5 h | U2 Full/Trickle/Storage Charging: | 13.50 V | +20 °C | Continuous | Safety mode at excess temperature of the battery: | 12.80 V | > +50 °C | |
| U1 Main/Full Charging: | 14.70 V (!) | +20 °C | 0.5-3.5 h | | | | | | | | | | |
| U2 Full/Trickle/Storage Charging: | 13.50 V | +20 °C | Continuous | | | | | | | | | | |
| Safety mode at excess temperature of the battery: | 12.80 V | > +50 °C | | | | | | | | | | | |
|  <p>1 2 3 4</p> | <p>These switch positions and other switch positions (such as for LiFePO) are not valid and are not used (service positions)! All LEDs are <u>flashing</u>, and the charging port is switched-off by the solar controller for reasons of safety.</p> | | | | | | | | | | | | |

| | | | | | | | | | |
|--|---|---------|---------------------|---------|-----------|----|--------------------------------|---------|------------|
| <p>Switch 1 "above": LiFePO4- Batteries</p>  <p>1 2 3 4</p> | <p>d) – h): Charging Programs for LiFePO4-Batteries: </p> <ul style="list-style-type: none"> • The charging regulations of the battery manufacturer are absolutely to be observed! • An operation of the unit at a LiFePO4 battery without BMS Battery Management System and without equalization charging of the cells (balancing) as well as safety circuit is not admissible! • A battery temperature sensor must be installed at the battery (screw to the negative pole) and connected at the unit. It serves as protection for the battery! • If possible, the battery temperature must be kept above 0 °C. <p>Note: The possible parallel/floating operation with consumers being connected to the battery is also automatically considered by all charging programs.</p> | | | | | | | | |
|  <p>1 2 3 4</p> | <p>d) "LiFePO4 13.9 V": Charging program IU1oU2</p> <table border="1" data-bbox="384 629 1476 707"> <tr> <td>U1</td> <td>Main/Full Charging:</td> <td>13.90 V</td> <td>0.5-1.5 h</td> </tr> <tr> <td>U2</td> <td>Full/Trickle/Storage Charging:</td> <td>13.90 V</td> <td>Continuous</td> </tr> </table> | U1 | Main/Full Charging: | 13.90 V | 0.5-1.5 h | U2 | Full/Trickle/Storage Charging: | 13.90 V | Continuous |
| U1 | Main/Full Charging: | 13.90 V | 0.5-1.5 h | | | | | | |
| U2 | Full/Trickle/Storage Charging: | 13.90 V | Continuous | | | | | | |
|  <p>1 2 3 4</p> | <p>e) "LiFePO4 14.2 V": Charging program IU1oU2</p> <table border="1" data-bbox="384 831 1476 909"> <tr> <td>U1</td> <td>Main/Full Charging:</td> <td>14.20 V</td> <td>0.5 h</td> </tr> <tr> <td>U2</td> <td>Full/Trickle/Storage Charging:</td> <td>13.60 V</td> <td>Continuous</td> </tr> </table> | U1 | Main/Full Charging: | 14.20 V | 0.5 h | U2 | Full/Trickle/Storage Charging: | 13.60 V | Continuous |
| U1 | Main/Full Charging: | 14.20 V | 0.5 h | | | | | | |
| U2 | Full/Trickle/Storage Charging: | 13.60 V | Continuous | | | | | | |
|  <p>1 2 3 4</p> | <p>f) "LiFePO4 14.4 V": Charging program IU1oU2</p> <table border="1" data-bbox="384 1021 1476 1099"> <tr> <td>U1</td> <td>Main/Full Charging:</td> <td>14.40 V</td> <td>0.3-1 h</td> </tr> <tr> <td>U2</td> <td>Full/Trickle/Storage Charging:</td> <td>13.80 V</td> <td>Continuous</td> </tr> </table> | U1 | Main/Full Charging: | 14.40 V | 0.3-1 h | U2 | Full/Trickle/Storage Charging: | 13.80 V | Continuous |
| U1 | Main/Full Charging: | 14.40 V | 0.3-1 h | | | | | | |
| U2 | Full/Trickle/Storage Charging: | 13.80 V | Continuous | | | | | | |
|  <p>1 2 3 4</p> | <p>g) "LiFePO4 14.6 V": Charging program IU1oU2</p> <table border="1" data-bbox="384 1200 1476 1279"> <tr> <td>U1</td> <td>Main/Full Charging:</td> <td>14.60 V</td> <td>0.3-1 h</td> </tr> <tr> <td>U2</td> <td>Full/Trickle/Storage Charging:</td> <td>13.60 V</td> <td>Continuous</td> </tr> </table> | U1 | Main/Full Charging: | 14.60 V | 0.3-1 h | U2 | Full/Trickle/Storage Charging: | 13.60 V | Continuous |
| U1 | Main/Full Charging: | 14.60 V | 0.3-1 h | | | | | | |
| U2 | Full/Trickle/Storage Charging: | 13.60 V | Continuous | | | | | | |
|  <p>1 2 3 4</p> | <p>h) "LiFePO4 14.8 V": Charging program IU1oU2, adapted to the former LiFePO4 batteries with high charging voltage! Only for special application!</p> <table border="1" data-bbox="384 1402 1476 1480"> <tr> <td>U1</td> <td>Main/Full Charging:</td> <td>14.80 V</td> <td>0.3-1 h</td> </tr> <tr> <td>U2</td> <td>Full/Trickle/Storage Charging:</td> <td>13.65 V</td> <td>Continuous</td> </tr> </table> | U1 | Main/Full Charging: | 14.80 V | 0.3-1 h | U2 | Full/Trickle/Storage Charging: | 13.65 V | Continuous |
| U1 | Main/Full Charging: | 14.80 V | 0.3-1 h | | | | | | |
| U2 | Full/Trickle/Storage Charging: | 13.65 V | Continuous | | | | | | |

Further actions at the unit are not required during normal automatic mode.



Declaration of Conformity:

In accordance with the provisions of the statutory requirements and the relevant directives, Electrical Equipment (Safety) Regulations 2016, Electromagnetic Compatibility Regulations 2016, The Restriction of the Use of Certain Hazardous Substances in Electrical and Electronic Equipment Regulations 2012 this product complies with the following standards or normative documents:
BS EN55014-1; BS EN61000-6-1; BS EN61000-4-2; BS EN61000-4-3; BS EN61000-4-4; BS EN62368-1; BS EN50498, BS EN IEC 63000.

Charging Voltage Rates and Temperature Compensation of BOARD Battery I:

TS = With Temperature Sensor (Terminals „TS TS“). Highly recommended for protection of LiFePO4 batteries!

a) Lead "GEL", IU1oU2

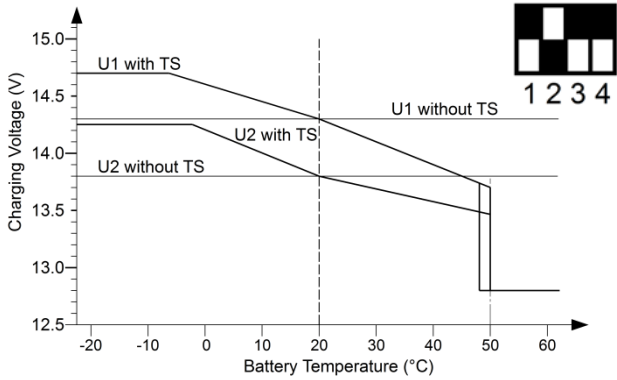

b) Lead "Lead Acid/AGM1", IU1oU2

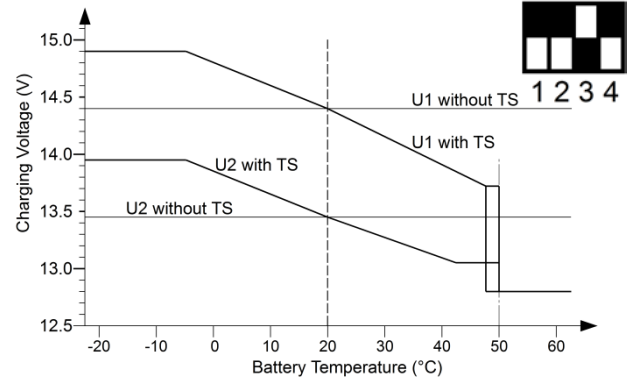

c) Lead "AGM2", IU1oU2

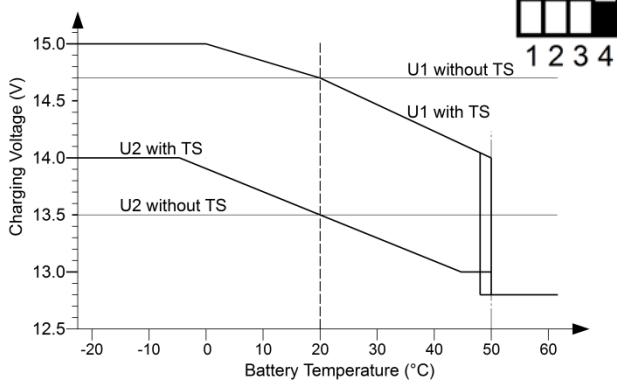

d) LiFePO4 13,9V

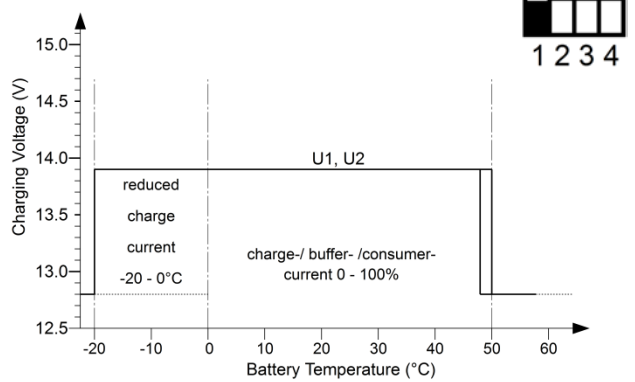

e) LiFePO4 14,2V

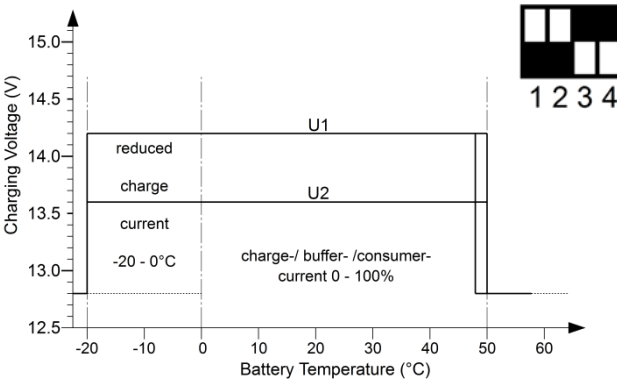

f) LiFePO4 14,4V

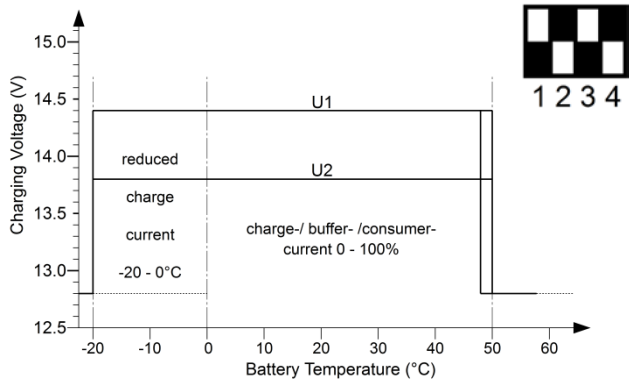

g) LiFePO4 14,6V

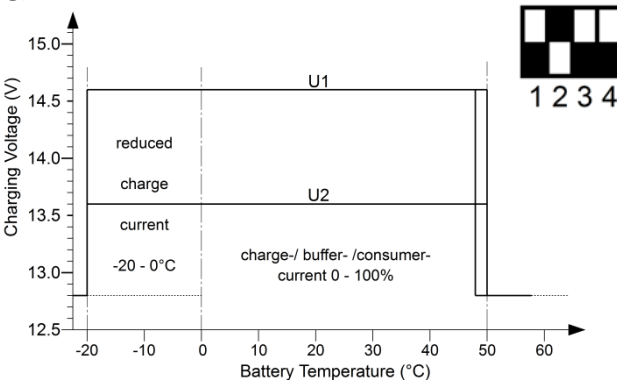

h) LiFePO4 14.8 V, only for special application!

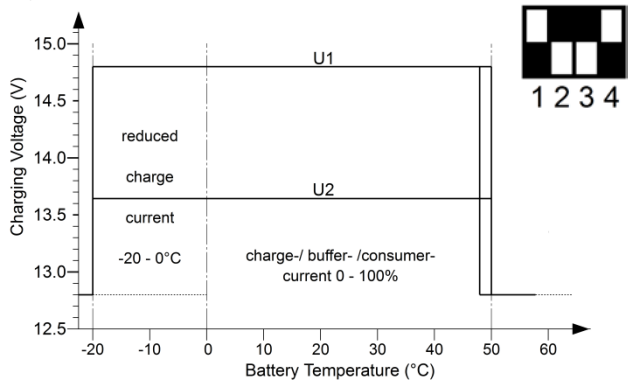

Functions at the Main/Board Battery "Board I":

If **solar power is missing** (at night), the readiness for service of the controller will be indicated by short **flashing** of the LED (light-emitting diode) "**MPP**".

As soon as sufficient solar power is available, a lighting LED "**MPP**" indicates proper control functions of the solar controller. The **most favourable working point** for the coordination of solar panel, cabling and battery is always ensured. The brightness is also a measure for the converted solar power: The brighter, the more the power (MPP 165: brightness of the LED "Charge").

1. Gentle preliminary charging of a **totally discharged** (lead) **battery**, indicated by the LED "**Batt. Low**" (low voltage).
2. Maximum charging current (**Phase I**) in the lower and mean voltage range of the battery up to the beginning of the phase U1. The **MPP** control adjusts itself to the maximum working point of the solar panel, and - in contrast to conventional controllers - thus achieves the highest possible battery charging current for short charging times under the given circumstances (sunlight, module orientation, module temperature and module soiling).
3. The solar controller will control the charging time, as well as the charging current and will switch automatically to the following phase U1=full charge.
4. During the following **phase U1** the battery voltage will be kept constant on a high level, the battery determines the charging current according to its charging state, the high battery capacity will be charged, the LED ">80 %" is lighting and "**Batt. Full**" is lighting dimly. A battery, which is already fully charged will be held in the phase U1 for a short time, a partially discharged battery will be held in this phase correspondingly longer for the purpose of full charging and equalization charging of the cells (maintenance).
The MPP control ensures lower panel load and panel temperature, thus allowing an increased efficiency, if additional consumers are switched-on.
5. During the **phase U2** (Full charging/trickle charging) the battery will be kept on its charging level. Only the compensating recharging current is flowing being required for conservation of the full charge, which is determined by the battery. The duration of that phase is not limited, the LED "**Batt. Full**" is **lighting intensively**, LED ">80 %" extinguishes. In contrast to conventional controllers, especially here, the MPP control ensures low panel loads and panel temperatures. The supply of additional consumers is improved, and the solar power is almost completely available to the consumers.

Switching back to the phase I or U1 is effected, if the battery had been subject to load for an extended period, or if the solar controller switches to stand-by mode after sunset.

If a **temperature sensor** is used for the lead battery, the voltage values will be slightly higher in case of low outside temperatures, while they will be slightly lower in case of high outside temperatures.

For LiFePO4 batteries a **valuable battery protection** is achieved, which is particularly recommendable below 0 °C!

MPP 250, 350, 430: The LED "**AES**" is lighting in case of permanent excess solar power (towards the end of the phase U1 and during the phase U2). The output AES is active.

The output for battery II (START II) is adapted to the lead starter battery. It works with reduced voltage and charging current rates. Thus, the valuable solar power will be supplied to board/solar battery "I" being more suitable. However, the starter battery "II" will be kept in a condition, that starting will always be possible, even in case of longer stop periods (such as in winter).

Charging Process (Characteristic Line of Charging IU1oU2) at the Board Battery "BOARD I" in Case of Sufficient Solar Power:

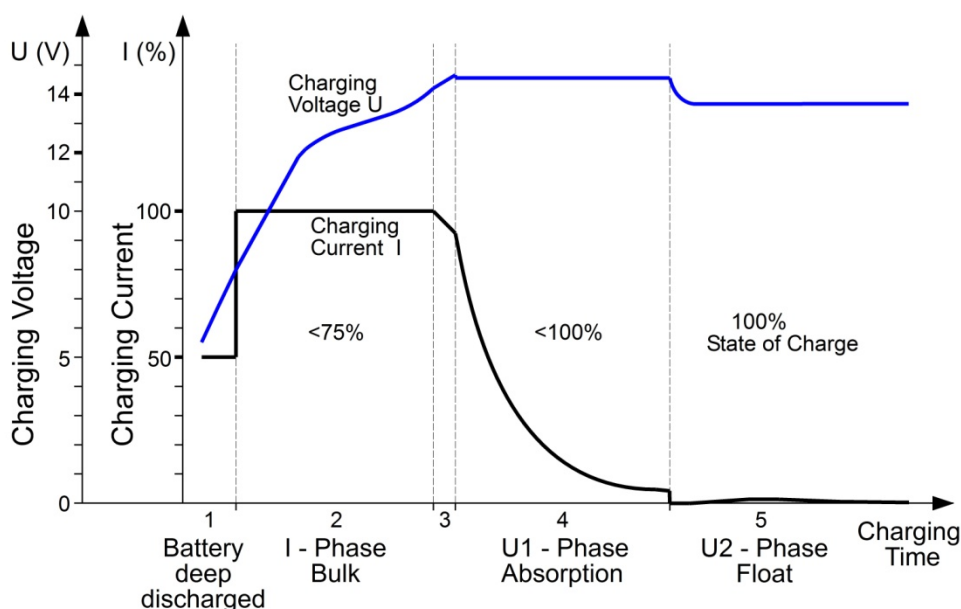

| Technical Data: | MPP 165 Duo Digital | MPP 250 Duo Digital | MPP 350 Duo Digital | MPP 430 Duo Digital |
|--|--|--------------------------------|--------------------------------|--------------------------------|
| Capacity Solar Module (recommended min. to max.): | 40 - 165 Wp | 50 - 250 Wp | 50 - 350 Wp | 50 - 430 Wp |
| Current Solar Module, 0 to maximum: | 0 - 10 A | 0 - 15.0 A | 0 - 21.0 A | 0 - 26.0 A |
| Voltage Solar Module, max. Open Circuit Voltage (Voc): | max. 50 V | max. 50 V | max. 50 V | max. 50 V |
| Protection against Back Discharge (Night Operation): | Yes | Yes | Yes | Yes |
| Main Port Battery I (BOARD I): | | | | |
| Charging/Floating/Load Current: | 0 - 12.0 A | 0 - 18.0 A | 0 - 25.5 A | 0 - 31.5 A |
| Max. Prelim. Charg. Current (Totally Discharged Battery): | 6 A (<8V) | 9 A (<8V) | 12.7 A (<8V) | 15.7 A (<8V) |
| Nominal Voltage Battery Lead-Acid, Gel, AGM: | 12 V | 12 V | 12 V | 12 V |
| Recom. min. Battery Capacity (max. acc. to application): | > 40 Ah | > 60 Ah | > 80 Ah | > 100 Ah |
| Nominal Voltage Battery LiFePO4: | 12.8 - 13.2 V | 12.8 - 13.2 V | 12.8 - 13.2 V | 12.8 - 13.2 V |
| Recom. min. Battery Capacity (max. acc. to application): | > 30 Ah | > 45 Ah | > 70 Ah | > 90 Ah |
| Charging Programs for Gel/AGM/Acid/LiFePO4 Batteries: | 8 | 8 | 8 | 8 |
| Charging Voltage Limitation (max.): | 15.0 V | 15.0 V | 15.0 V | 15.0 V |
| Installed, Limitation of Charging Current /Overload Protection: | Yes / Yes | Yes / Yes | Yes / Yes | Yes / Yes |
| Installed, Overtemperature/Short-circuit Protection: | Yes / Yes | Yes / Yes | Yes / Yes | Yes / Yes |
| Installed, Cooling Fan with Temp. Control: | -- | Yes | Yes | Yes |
| Current Consumption Stand-by | 4 mA | 4 mA | 4 mA | 4 mA |
| Unit Fuse (Type FKS): | 15 A | 20 A | 30 A | 40 A |
| Input for Battery I Temperature Sensor: | Yes | Yes | Yes | Yes |
| Charging Timer: | 3-fold | 4-fold | 4-fold | 4-fold |
| Plug-and-go Connect. For Displays, such as LCD Solar Comput. S: | Yes | Yes | Yes | Yes |
| Signal Output for "EBL" Display "Solar Charging Current": | Yes | Yes | Yes | Yes |
| Control Output "AES" Refrigerator, max. Rating: | -- | 12 V / 0.2 A | 12 V / 0.2 A | 12 V / 0.2 A |
| Auxiliary Port Vehicle Starter (Lead) Battery (Start II): | | | | |
| Nominal Voltage/Charging Current: | 12V / 0 - 1.0 A | 12V / 0 - 1.0 A | 12V / 0 - 1.0 A | 12V / 0 - 1.0 A |
| Installed, Limitation of Charging Current / Overload Protection: | Yes / Yes | Yes / Yes | Yes / Yes | Yes / Yes |
| Installed, Overtemperature / Short-circuit Protection: | Yes / Yes | Yes / Yes | Yes / Yes | Yes / Yes |
| Dimensions, incl. Mounting Flanges (mm): | 131 x 77 x 40 | 131 x 77 x 40 | 131 x 77 x 40 | 131 x 77 x 40 |
| Weight: | 225 g | 235 g | 285 g | 285 g |
| Ambient Temperature Range, Humidity of Air: | -20 to +45°C, max. 95 % r. H., no condensation | | | |



Declaration of Conformity:

In accordance with the provisions of Directives 2014/35/EU, 2014/30/EU, 2009/19/EC, this product complies with the following standards or normative documents:
EN55014-1; EN55022 B; EN61000-6-1; EN61000-4-2; EN61000-4-3; EN61000-4-4;
EN62368-1; EN50498.



The product must not be disposed of in the household waste.



The product is RoHS compliant. It complies with the directive 2015/863/EU for Reduction of Hazardous Substances in electrical and electronic equipment.



Recycling:

At the end of its useful life, you can send us this device for professional disposal: You can find more information about this on our website at www.votronic.de/recycling

| Delivery Scope: | Available Accessories: | |
|------------------------|---|----------------|
| • MPP Solar Controller | - Temperature Sensor 825 | Order No. 2001 |
| • Operating Manual | - LCD Solar Computer S | Order No. 1250 |
| | - Cable set for connection of the solar controller to EBL | Order No. 2007 |

Subject to misprints, errors and technical modification without notice.

All rights reserved. This material may not be published, broadcast, rewritten or redistributed in whole or part without the express written consent of the manufacturer. Copyright VOTRONIC 11/2022.

Made in Germany by VOTRONIC Elektronik-Systeme GmbH, Johann-Friedrich-Diehm-Str. 2, 36341 Lauterbach/GERMANY
Phone: +49 (0)6641/91173-0 Fax: +49 (0)6641/91173-10 E-Mail: info@votronic.de Internet: www.votronic.de